

VICTOR REINZ®

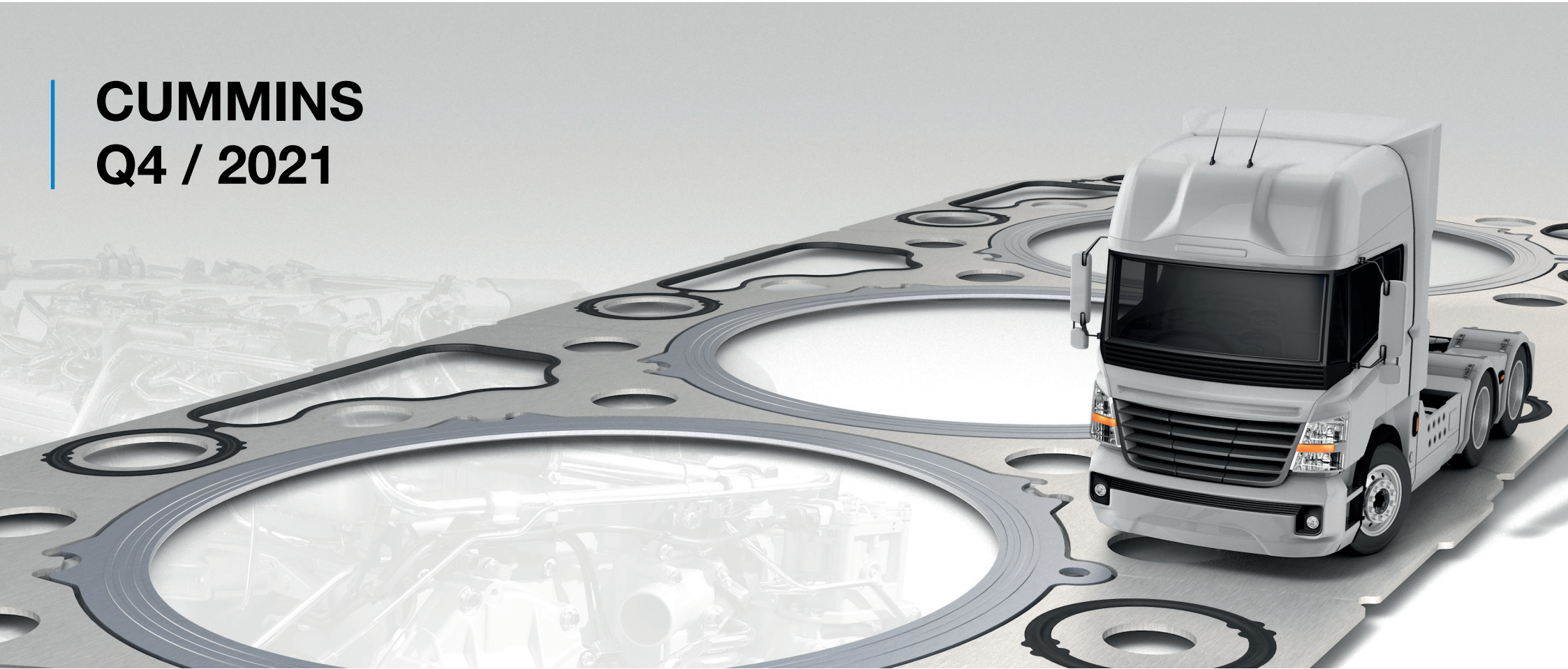

CUMMINS
Q4 / 2021



VictorReinz.com/online-catalog

Victor Reinz®

at a Glance



Online Catalog

VictorReinz.com/online-catalog



Newsletter

VictorReinz.com/EN/News/Newsletter.aspx?region



Youtube

www.youtube.com/user/VictorReinzSealingEN

Catalog News

VictorReinz.com/news

Technical Service Information

VictorReinz.com/tsi

Facebook

www.facebook.com/VictorReinzParts

Just seal it!

VictorReinz.com/jsi

Technical Datasheet

VictorReinz.com/jsi-datasheet

LinkedIn

www.linkedin.com/showcase/victor-reinz-emea

Safety Datasheet

VictorReinz.com/jsi-datasheet

Homepage

VictorReinz.com

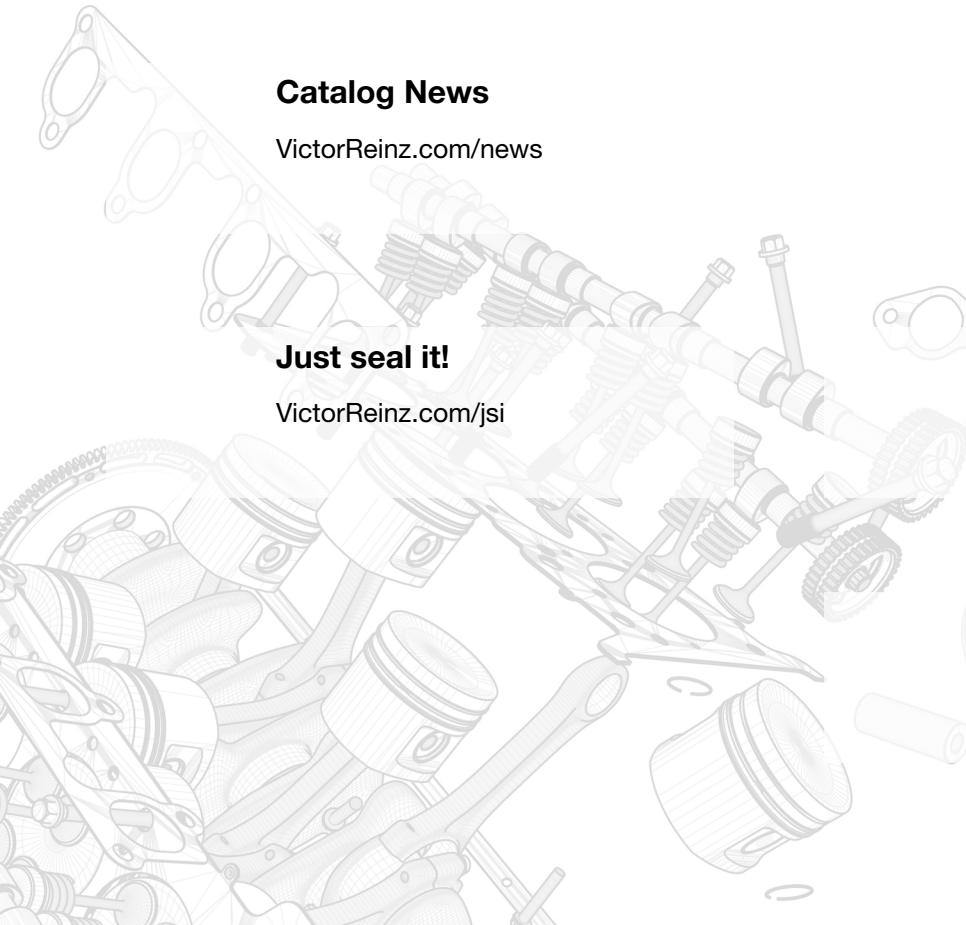

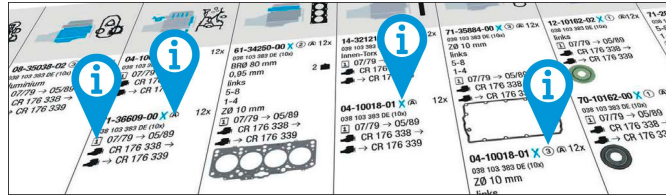

VictorReinz.com/catalog-info

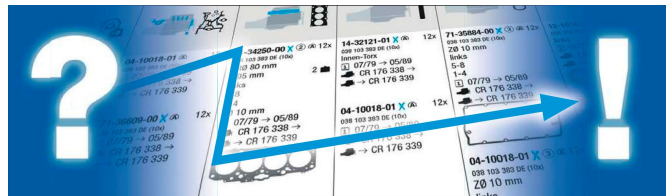

VictorReinz.com/catalog-how-to-use

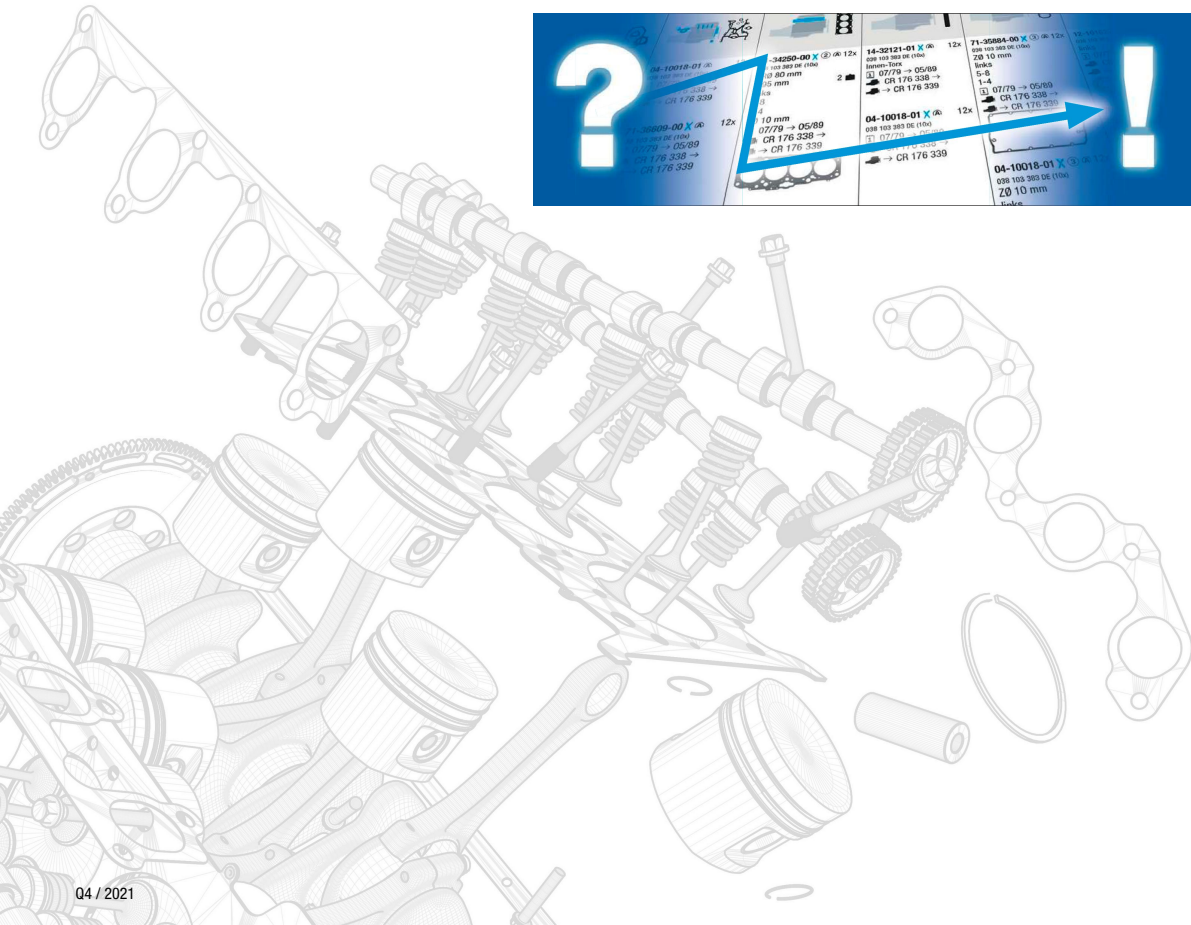

CUMMINS



















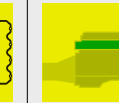
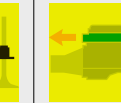
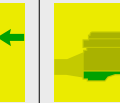







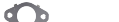





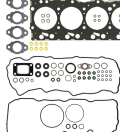

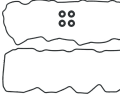
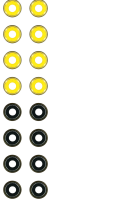

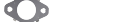





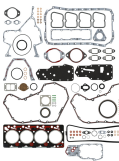
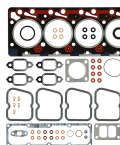







0-9	
4 BT	5
4 BT 3.9	5
4 BTA 3.9	5
4 BTAA	5
6 B5.9	6
6 BT	6
6 BT5.9	6
6 BTA-180	6
6 BTA-5.9	6
6 BTAA	6
6 CT	7
6 CT 8.3	7
6 CTA 8.3	7
I	
ISB 4.5	6
ISB-160	6
ISB-185	6
ISB-215	6
ISB-220	6
ISB-235	6
ISB-250	6
ISB-275	6
ISB6.7	7
ISBe-135	5
ISBe-150	5
ISBe-170	5
ISBe-220	6
ISBe-230	6
ISBe-250	6
ISBe-250 30	6
ISBe-275	6
ISF3.8	5
ISM 280	8
ISM 310	8
ISM 320	8
ISM 330	8
ISM 345	8
ISM 350	8
ISM 370	8
ISM 375	8
ISM 380	8
ISM 400	8
ISM 410	8

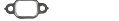















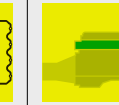
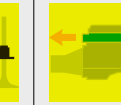
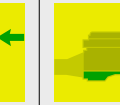





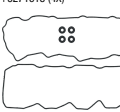











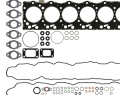
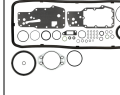











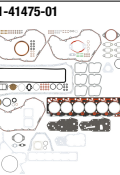
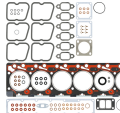
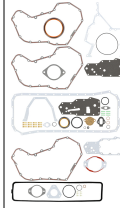





















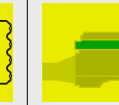
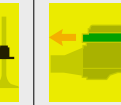
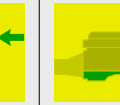

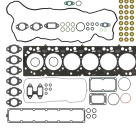
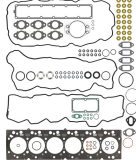

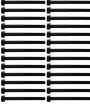

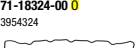



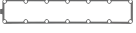

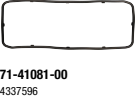





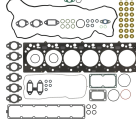
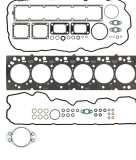

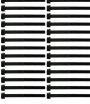

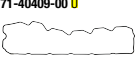





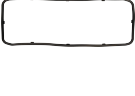





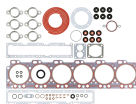

ISM 425	8
ISM 460	8
ISX 400	10
ISX 425	10
ISX 450	10
ISX 460	10
ISX 470	10
ISX 475	10
ISX 485	10
ISX 500	10
ISX 525	10
ISX 530	10
ISX 550	10
ISX 565	10
ISX 575	10
ISX 600	10
ISX12-310	9
ISX12-330	9
ISX12-350	9
ISX12-370	9
ISX12-400	9
ISX12-425	9
L	
L 10	8
L 10-250	8
L 10-280	8
L 10-330	8
L 10-400	8
LT 10	8
LT 10-290	8
LT10-250 Turbo	8
M	
M11	8
N	
N14	9
NT 855	9
Q	
QSB 173	7
QSB 220	7
QSL9-230	8
QSL9-250	8



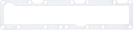













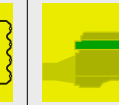
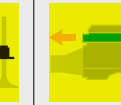
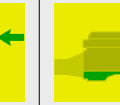













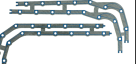

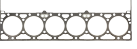
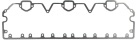















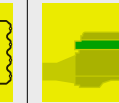
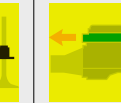
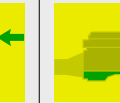







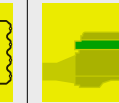
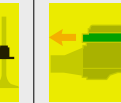
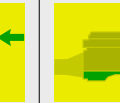

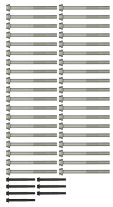
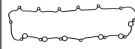
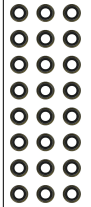









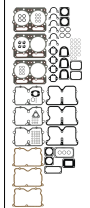
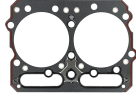

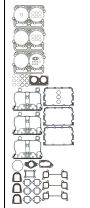
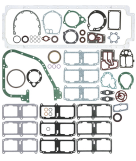
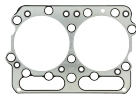

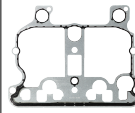



QSL9-285	8
QSL9-290	8
QSL9-331	8
QSL9-335	8
QSL9-400	8
QSL9-406	8
QSL9-410	8
QSL9-456	8
QSX15-268	10
QSX15-298	10
QSX15-317	10
QSX15-328	10
QSX15-354	10
QSX15-373	10
QSX15-391	10
QSX15-403	10
QSX15-418	10
QSX15-447	10
X	
X15 450	10
X15 600	10
X15 550	10

















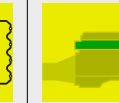
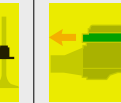
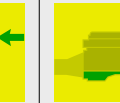



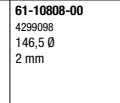
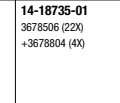
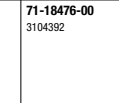

CUMMINS													
ISF3.8	4 Zyl.	3.8 Ltr.			08-20188-01 5290108		61-11205-00 5345648 1,25 mm		71-11223-00 4946239 	12-40336-01 3955393 (16X)  70-40336-00 3955393  16x	71-11222-00  4983020  71-36917-10  4x 2830444 	71-20188-00 4995750 	81-10603-00  5338295 67x100x13 A SL RD  81-10442-00  3968563 130x150x14 A SL LD PTFE 
ISBe-135 ISBe-150 ISBe-170	4 Zyl.	3.9		02-36410-01 4089780 	08-36834-01 4025108 		61-36410-00 2830707 1,15 mm 61-36410-10 2830706 1,25 mm 		15-36833-02 4899228 +4899230 +5271613 (4X) 	12-37102-01 3942989 (8X) +3945438 (8X) 	71-36917-10  4x 2830444 	71-36834-00 4939246 	81-10603-00  5338295 67x100x13 A SL RD  81-36999-00  4890833 130x155x12,57 PTFE 
4 BT 4 BT 3.9 4 BTA 3.9 4 BTAA	4 Zyl.	3.9	01-41450-01 	02-41450-01 3804896 	08-41450-01 3802375 		61-41450-00 3283333 106 Ø 		71-33594-00 3930906 	70-41469-00 3921640  04/03  70-19432-00 3957912  05/03 	71-41442-00  8x 3938153  71-41443-00  4x 3927154 	10-41450-01 71-42008-00 3938162 	81-10004-00  3937111 63x79,6x8 B SL RD PTFE   81-10167-00  3934486 129,5x148,3x14,3 AB SL LD PTFE  

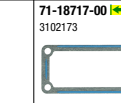
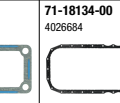
CUMMINS													
ISB 4.5	4 Zyl.	Ltr. 4,5		02-37790-01 4955356 	08-36834-03 4955357 		61-37790-00 4932209 1,2 mm 		15-36833-02 4899228 +4899230 +5271613 (4X) 	12-40336-01 3955393 (16x)  70-40336-00 3955393 16x 	70-31414-10    71-36917-10  2830444 	71-36834-00 4899246 	81-36998-00 K  5338295 70x100x12,67  81-40422-00 K  130x150x14,8 A SL LD PTFE 
ISBe-220 ISBe-230 ISBe-250 ISBe-250 30 ISBe-275 ISB-160 ISB-185 ISB-215 ISB-220 ISB-235 ISB-250 ISB-275	6 Zyl.	5,9		02-36415-01 4089781 	08-36927-01 4025139 		61-36415-00  2830705 1,15 mm 61-36415-10 2830704 1,25 mm 		15-36836-02 	12-37102-02 	71-36917-10  2830444 	71-36927-00 4834344 	81-36998-00 K  5338295 70x100x12,67  81-36999-00 K  4890833 130x155x12,57 PTFE 
6 BT 6 BTAA 6 BTA-5.9 6 BTA-180 6 BT5.9 6 B5.9	6 Zyl.	5,9		02-41475-01 3804897 	08-41475-01 3802376 		61-41475-00 3283335 106 Ø 		71-33594-00 3930906 	70-41469-00 3921640 	71-41467-00  3931347  71-41443-00  3927154 	71-41466-00 3911536 	81-10004-00 K  3937111 63x79,6x8 B SL RD PTFE  81-10167-00 K  3934486 129,5x148,3x14,3 AB SL LD PTFE 

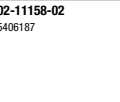
CUMMINS													
ISB6.7	6 Zyl.	Ltr. 6,7		<p>02-37980-02 4932210 109,5 Ø 1,2 mm</p>  <p>02-37980-04 4955523</p> 			<p>61-37980-00 4932210 109,5 Ø 1,2 mm</p> 	<p>14-11227-01 3927063 (26X)</p> 	<p>71-11226-00 U 3963379</p>  <p>71-18324-00 O 3954324</p>  <p>71-36836-00 O 5309255</p> 	<p>12-40336-02 3955393 (24X)</p>  <p>70-40336-00 3955393</p> 	<p>71-11229-00 I </p> <p>3947530</p>  <p>71-11228-00  6x 5447591</p> 	<p>71-36927-00 4934344</p>  <p>71-41081-00 4337596</p> 	<p>81-10603-00 K </p> <p>5338295 67x100x13 A SL RD</p>  <p>81-10604-00 K </p> <p>5259499 130x150x9,7 PTFE</p> 
OSB 173 OSB 220	6 Zyl.	6,7		<p>02-37980-02</p>  <p>02-37980-03 4955229</p> 		<p>61-37980-00 4932210 109,5 Ø 1,2 mm</p> 	<p>14-11227-01 3927063 (26X)</p> 	<p>71-11226-00 U 3963379</p>  <p>71-36836-00 O 5309255</p>  <p>71-40409-00 U</p> 	<p>12-40336-02 3955393 (24X)</p>  <p>70-40336-00 3955393</p> 	<p>71-11229-00 I </p> <p>3947530</p>  <p>71-11228-00  6x 5447591</p> 	<p>71-36927-00 4934344</p> 	<p>81-10603-00 K </p> <p>5338295 67x100x13 A SL RD</p>  <p>81-10604-00 K </p> <p>5259499 130x150x9,7 PTFE</p> 	
6 CT 6 CT 8.3 6 CTA 8.3	6 Zyl.	8,3		<p>02-41455-01 5579026</p> 	<p>08-41455-01 3800558</p> 		<p>61-41455-00 3938267 123,6 Ø</p> 		<p>71-41444-00 3905449</p> 	<p>12-45069-01 3915707 (6x) +3919038 (6x)</p> 	<p>71-41447-00 I </p> <p>3921440</p>  <p>71-41448-00 I </p> <p>3914311</p>  <p>71-41449-00  6x 3929012</p> 	<p>71-41446-10 5332563</p> 	

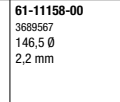
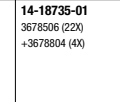
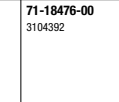
CUMMINS													
QSL9-230 QSL9-250 QSL9-285 QSL9-290 QSL9-331 QSL9-335 QSL9-400 QSL9-406 QSL9-410 QSL9-456	6 Zyl.	8,9	02-11176-02 5473321 02-11176-03 5473319	08-41446-01 2882049 08-41446-02 5406119	61-11176-00 5529514 124 Ø 1,75 mm		71-18169-00 U 5272959 71-19618-00 O 3959798 	12-20140-01 5448124 (24X) 70-20140-00 5448124	71-19534-00 I 4937032 71-18162-00 5269779  	71-41446-10 5332563 	81-10640-00 K 4024883 75x93x8 RD PTFE  81-10604-00 K 5259499 130x150x9,7 PTFE 		
L 10 L 10-250 L 10-280 L 10-330 L 10-400 LT 10 LT 10-290 LT10-250 Turbo	6 Zyl.	10,0	02-41460-02 4024993	08-18452-01 4089998	61-41460-00 2864080 134 Ø 		71-19408-00 O 3883220 71-41451-00 U 4070529 	12-18562-01 4003966 (24X)  70-18562-00 4003966 	71-19410-00 I 3069786 71-11228-00 5447591  71-41452-00 3328948 	71-18452-00 5394102 	81-10614-00 K 4955665 85,5x99,5x5,5 PTFE 81-10641-00 K 4089544 166x190x12 LD PTFE 		
ISM 280 ISM 310 ISM 320 ISM 330 ISM 345 ISM 350 ISM 370 ISM 375 ISM 380 ISM 400 ISM 410 ISM 425 ISM 460 M11	6 Zyl.	10,8	02-41460-02 4024993	08-18452-01 4089998	61-41460-00 2864080 134 Ø 		71-19408-00 O 3883220 71-41451-00 U 4070529 	12-18562-01 4003966 (24X)  70-18562-00 4003966 	71-19410-00 I 3069786 71-11228-00 5447591  71-41452-00 3328948 	71-18452-00 5394102 	81-10614-00 K 4955665 85,5x99,5x5,5 PTFE 81-10641-00 K 4089544 166x190x12 LD PTFE 		

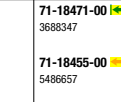
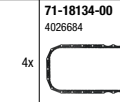
CUMMINS													
ISX12-310 ISX12-330 ISX12-350 ISX12-370 ISX12-400 ISX12-425	6 Zyl.	11,9 Ltr.											
				<p>02-11172-02 4376467</p>	<p>08-18563-01 2881966</p>		<p>61-11172-00 4975249 138,5 Ø 1,85 mm</p> 	<p>14-18560-01 4330988 (38X) +3093806 (7X)</p> 	<p>71-18531-00 2870214</p> 	<p>12-18562-01 4003966 (24X)</p>  <p>70-18562-00 4003966</p> 	<p>71-18124-00 </p> <p>3678770</p>  <p>71-18551-00  4x 4386982</p> <p>71-18553-00  1x 4386983</p>  <p>24x</p>	<p>71-18563-00 4975069</p>	<p>81-10618-00  3685173 RD PTFE ACM</p>  <p>81-10597-00  4965569 165,5x197x15,5 LD PTFE ACM</p> 
NT 855	6 Zyl.	14,0		<p>02-41480-01 3801330</p> 	<p>08-41480-01 08-41485-01</p>		<p>61-41480-00 3x 3049998 157 Ø</p> 					<p>71-40706-00 3099083</p> 	
N14	6 Zyl.	14,0		<p>02-36580-01 4089371</p>  <p>02-36580-02 4089368</p>	<p>08-40706-02 4025069</p>  <p>08-40706-03 4025068</p>		<p>61-36580-00 3x 4058790 157 Ø 2 mm</p> 		<p>71-37364-00  3x 4058981</p>  <p>71-37366-00  3x 3066311</p> 	<p>12-19116-01 3064281 (24X)</p> <p>70-19116-00 3064281</p> <p>24x</p>	<p>71-37356-00  3x 3008951</p>  <p>71-37358-00  6x 3020943</p>  <p>71-37359-00  3x 3865235</p> 	<p>71-40706-00 3099083</p> 	<p>81-40647-00  3020183 92x121x12,5 B SL RD PTFE</p>  <p>81-40648-00  3006737 152,5x171,5x11 B LD PTFE</p> 

CUMMINS													
ISX 400 ISX 425 ISX 450 ISX 460 ISX 470 ISX 475 ISX 485 ISX 500 ISX 525 ISX 530 ISX 550 ISX 565 ISX 575 ISX 600	6 Zyl.	Ltr. 15,0											
OSK15-268 OSK15-298 OSK15-317 OSK15-328 OSK15-354 OSK15-373 OSK15-391 OSK15-403 OSK15-418 OSK15-447	6 Zyl.	15,0											
X15 450 X15 600 X15 550	6 Zyl.	15,0											

Haftungsausschluss (für Katalog)

Alle Angaben in unserem Katalog wurden von uns sorgfältig geprüft, sind jedoch unverbindlich. Ersatzansprüche wegen Katalogangaben werden von uns nicht anerkannt. Der Käufer ist selbst verpflichtet, zu prüfen, ob unsere Teile für seine Zwecke geeignet sind. In allen Zweifelsfällen sollte Rücksprache mit unserem technischen Kundendienst erfolgen **Tel. +49 731 7046 999**.

Technische Weiterentwicklungen oder Änderungen bleiben vorbehalten, soweit damit keine Nachteile für den Kunden verbunden sind.

Angaben, Namens- und Markenzeichen, Beschreibungen, Nummern von Fahrzeugnummern und Herstellerzeichen, Original-Ersatzteilnummern der Fahrzeug- und Motorenhersteller u. a. sind ausschließlich für interne Zwecke gedacht. Solche Kennzeichnungen dürfen Fahrzeugbesitzern gegenüber nicht verwendet werden.

Wir weisen ausdrücklich darauf hin, dass alle von uns gelieferten Teile von geschultem Fachpersonal einzubauen sind. Reinz haftet für Fehler in diesem Katalog nur, wenn diese für den Kunden nicht offenbar erkennbar sind sowie nur bei Vorsatz und grober Fahrlässigkeit von Reinz, eines Vertreters oder eines Erfüllungsgehilfen. Dieser Haftungsausschluss gilt nicht im Rahmen

des Anwendungsbereichs des Produkthaftungsgesetzes und nicht bei Verletzung von Körper, Leben und Gesundheit, sowie bei der Verletzung von sog. Kardinalpflichten. Darüber hinaus ist unsere Haftung für Schäden, insbesondere für Personen-, Sach- oder Vermögensschäden, die unmittelbar oder mittelbar im Zusammenhang mit der Nutzung dieses Kataloges auftreten, sowie für nicht voraussehbare Schäden ausgeschlossen.

Reinz ist Inhaber aller Schutzrechte an den in diesem Katalog gespeicherten Daten. Kopie, Nachdruck, ganze oder teilweise Übernahme der Inhalte und Vervielfältigung, auch auszugsweise, ist nur mit unserer vorheriger schriftlicher Zustimmung sowie mit unserem Urheberrechtsvermerk zulässig.

Für Bestellungen, welche ab dem Erscheinungsdatum eines neuen Katalogs getätigt werden, sind alleine die Angaben des neuen Katalogs maßgeblich. Auf Angaben im Vorkatalog kann bei Neubestellungen nicht mehr zurückgegriffen werden.

Sofern Sie noch Fragen haben, bitten wir Sie, sich mit uns in Verbindung zu setzen.

VictorReinz.com/AGB

Exclusion of Liability (for catalog)

All details in our catalog have been thoroughly checked by us but are however not binding. Right to damages on account of catalog details will not be recognized. The purchaser is obliged to check if our parts are suitable for their use. In all doubtful cases, the purchaser should consult our technical customer service under **+49 731 7046 999**.

We reserve the right to further technical developments or changes as long as no disadvantage for the customer results.

Details, name and trademarks, descriptions, numbers from vehicle numbers and manufacturer symbols, original vehicle replacement part numbers and engine manufacturer etc. are solely for internal use. Such labels must not be used with vehicle owners.

We specifically point out that all parts supplied by us must be assembled by trained specialists.

Reinz is liable for mistakes in this catalog only when they are not clearly recognizable for the customer, as well as by intent or gross negligence on the part of Reinz, its representative or vicarious agent. This exclusion of liability does not apply within the framework of the field of

application of the product liability laws and not by bodily harm, life and health, as well as by violation of cardinal duties. In addition, our liability for damages, especially personal, property or financial damages that occur directly or indirectly as a result of the use of this catalog, as well as non-foreseeable damages are excluded.

Reinz is the owner of all patent rights on the data stored in this catalog. Copies, reprints, whole or partial takeover of the contents and duplication even in excerpts are only permissible with our prior written approval, as well as with our copyright note.

For orders placed after the publication date of a new catalog, only the details in the new catalog are binding and no fall back to details in the previous catalog is possible.

In case you have further questions, do not hesitate to contact us.

VictorReinz.com/AGB

VictorReinz.com

reinz.info@dana.com

Technical Hotline +49 (0)731 7046-9 99

REINZ-Dichtungs-GmbH

Reinzstrasse 3-7
89233 Neu-Ulm
Germany
+49 (0)731 7046-0

VICTOR REINZ[®]

